



SPA-TECH Control System Instruction Manual



TABLE OF CONTENTS

GENERAL INTRODUCTION	1	Hose and pipe clearing cycle function	5
CONTROL SYSTEM FEATURE	1	Memory function	5
Compatibility	1	Expanding function	5
Safety	1	Default setting	5
Heating control	1	DIP SWITCH SETTING	6
Multimedia control	1	SPA - TECH CONTROL SYSTEM	
Expansibility	1	CIRCUIT DIAGRAM	7
SPA-TECH CONTROL PANEL	2	SPA - Tech control system master circuit diagram	7
SPA-Tech control panel operation instruction	2	SPA - Tech extension circuit diagram	7
Stand-by / startup	3	VOLTAGE JUMPER SET UP	7
Temperature setting	3	PROBLEM SHOOTING	8
Systemic time setting	3		
The filtering cycle setting	4		
Mode setting	4		
Light setting	5		
Massage automatically turns off function	5		
Digital diagnostics function	5		

GENERAL INSTRUCTION

- SPA - tech control system is specially designed for portable spa and swim spa, which have several Intelligent Control and self-protection technology. According to the numbers of pump, the system can be divided to two pumps system, three pumps system and four pumps system.
- The manual suit for both standard control version and luxury control version, please be kindly informed that some content only suit for luxury control version will comes with special remark.
- If some parts of the equipment are not available in your product, the related function is not available as well, the related button on the control panel should be ignored accordingly.
- The manufacturer reserves the right to modify part of the design or specifications without prior notice and without entering into any obligation.

CONTROL SYSTEM FEATURE

■ Compatibility

- The system can work in AC220~240V and AC380V , the frequency can work in 50Hz and 60Hz.
- The system can work with both circ pump system and dual speed pump system.
- The system reserve several control programs with 12 DIP switches setting.

■ Safety

- The control system have multi-self-protection program: water flow protection, high voltage protection, low voltage protection, low temperature protection, high temperature protection, super high temperature protection and anti dry heating protection to guarantee the system runs safely.
- Control box is made by ABS with water proof design up to IPX5.

■ Heater control

- The control system comes with a built-in heater to heat up the water.
- The control system can control heat pump or heat exchanger by setting different DIP of composited programme system.

■ Multimedia control

The control system support DVD, liftable TV, IPOD and different kinds of Audio medias.

■ Expansibility

The control system comes with excellent expansibility, through adding the extended circuit board, separated control panel, assistant control panel to achieve extra function.

SPA-TECH CONTROL

■ SPA-Tech control panel operation instruction

NOTES:



1. Above guide is used to Spa-Tech control panel only.
2. Key “Jets 1” : If it controls a 1 speed pump, it functions “Turn on/off” for this pump. If it controls a 2 speed pump, it functions “Turn on at high speed/turn to low speed/turn off”.



KEY	SYMBOL	FUNCTION	DESCRIPTION
POWER		Power	Turn on/off /standby
Jets 1		Pump 1	Turn on/off pump1
Jets 2		Pump 2	Turn on/off pump2
Blower		Air Blower pump	Turn on/off blower
Light		Lighting	Turn on/off light, and set light mode
Mode		Mode	1. Sleep/economy/standard mode 2. Yes/no
Time		Time setting	Time setting
Warm		Warm	Adjust Time/Temp(+)/Select modes
Cool		Cool	Adjust Time/Temp(-)/Select modes
Time+Warm		Time+Warm	Reverse/non-reverse time and temperatue display
Warm+Cool		Warm+Cool	Panel Locked(PL)/unlock panel
Time+Blower		Time+Blower	Restore factory settings
Mode+ Jets 1		Mode+ Jets 1	The pump work cycle setting

■ Stand-by / Power on ()

- **Stand by:** The SPA will automatically go into stand-by mode when the spa is properly supplied with power. In the stand-by mode, the current temperature will appear on the LCD screen, and the Thermostatic function and filtration cycle will get started as per the default setting. No back light on the screen.

Note: In the stand-by mode, except “  ” button and “  ” button, no buttons are available.

Stand-by mode



- **Power on:** Press the “  ” button, the screen will be illuminated and all the buttons on the panel are available.

Note: When leaving the spa run for one hour without touching any panel's buttons, the system will automatically go into stand-by mode, and the screen light will be turned off.

Power on



■ Temperature setting (+)

- The SPA comes with thermostatically controlled heater; set the temperature from the control panel, when the actual temperature is lower than the set temperature, the heater will automatically turn on to heat the spa water.

Note: Only the spa equipped with heat pump have the cooling function.

- In the power on mode, the screen displays the actual water temperature. When “Warm” or “Cool” button is pressed, the digital number showing the set temperature will flash, press “Warm” or “Cool” again to change the set temperature. After 5 seconds, the digital numbers will stop flashing and begin to display the current spa temperature, temperature setting complete.

- To raise the set temperature press the “Warm” button. To lower the set temperature, press the “Cool” button. The temperature set point (set temperature) can be adjusted from 10°C to 40°C.

■ Systemic time setting (+)

- Press “Time” button, the current time will be displayed. Program the clock by pressing the “Mode” button and the digital display window will display a digital clock with the HOUR setting flashing. Use the “Warm” or “Cool” buttons to change to the correct HOUR. When the HOUR is correct, press the “Mode” button to save changes and go to minutes setting. Use the “Warm” or “Cool” Buttons to change to the correct MINUTES. When the MINUTES are correct, press the “Mode” button to save changes and complete the time setting.



Before setting the time



After setting the time

Note:

1. The time displayed in the screen is 12-hour clock, AM means "before midday", and PM means "after midday"
2. If the HOUR and MINUTE of the time don't need to be changed, press "MODE" twice to skip it;
3. Program the time setting as per the above procedures, if leaving the buttons alone for 5 seconds, you will exit the time setting.
4. The clock will remain ticking when the spa is turned off or powered off suddenly, no need to adjust the time when the spa is turned on again.

■ The filtering cycle setting (🕒 + ⚙️)

- When the “TIME” icon appearing on the screen, press “🕒”, then press “⚙️”, select the hour by pressing “⬆️” or “⬇️”. Press “⚙️” to enter select the minute by pressing “⬆️” or “⬇️”. Press “⚙️” to exit the time setting procedure and enter the filter cycle setting programming.
- The “FILTER1, START TIME” appearing on the screen. Select the hour by press “⬆️” or “⬇️” to set up the start time for 1st filter cycle, press “⚙️” enter .
- “FILTER1 END TIME” appearing on the screen. Press “⬆️” or “⬇️” to set the “FILTER1 END TIME” for 1st filter cycle. Press “⚙️” exit the 1st filter cycle and enter the 2nd filter cycle setting.
- Select hour by press “⬆️” or “⬇️” to set the start time of the 2nd filter cycle setting, press “⚙️” enter.
- Press “⬆️” or “⬇️” to set the “FILTER2 END TIME” for 2st filter cycle. Press “⚙️” to exit programming.

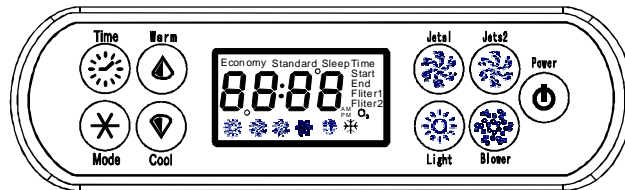

Notes:

1. Only the hours can be set for the filter cycle.
2. If you don't want to change the setting, please press “Mode” to exit. If it is stopped or no operation within 5 seconds during the setting. The system will exit the setting automatically. And the setting is failed.
3. The filter cycle run only when the spa is on stand-by mode. In this case, the control panel will show “O3”. When the spa is powered on, the filter cycle will not be operated.
4. Different time setting will be recommended. If the time setting is same, only 1 time filter cycle will be operated.

■ Mode setting (⚙️)

There're 3 modes, “Standard”, “Economy” and “Sleep”.

Standard mode: Heater is always on to maintain the set temperature.

Economy mode: Heater is on only during filtering period. Heater will be automatically turned on for frozen protection as soon as the water temperature is lower than 11 degree.

Sleep mode: Heater will be on only for frozen protection as soon as the water temperature is lower than 11 degree.

How to set the modes: Press “mode” button to enter the mode setting. Then, press “warm” or “cool” button to select different modes. Finally, press the “mode” button to set the mode.

How to activate economy mode: Economy mode works only under standby status. After setting economy mode, the screen will show “standard” signal and at the same time the “economy” signal is flashing. Press the “🔘” button to enter standby status for activating the economy mode.

Standard mode



Economic mode (Power on)



Sleep mode



Economic mode (Stand-by)

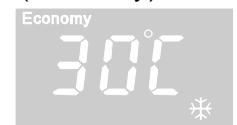



■ Light Setting ()

Press the button “Light” to turn on the light, once again to turn off the light, press the button again to turn the light and change into another mode.

■ Automatically turns off

If no buttons press for a while, the on running JET1, JET2 and blowers will automatically turn off. Press the relevant button to start again.

Note: If the heater is on working and the Jet1 is dual speed pump, then Jet1 will automatically turn to the low speed, and it will not stop running until the heater stop.

Note: Press ( + ) to reset the automatic turn off time. There are three options: 15minutes, 30minutes, 60minutes. P15, P30, P60 will display after set.

■ Digital diagnostics function

The control system will automatically turn on the protect function after error message appear on the LCD display if there is probably something wrong with the SPA, you can refer to “Trouble shooting” to deal with these problem or provide these information to your dealer.

■ Hose and pipe clearing cycle

The system will turn on air-blower and massage pump high speed for 3~4 minutes to clean the hose and pipe in every filtration cycle.

Memory function

- The system will revert to the last setting after each power on.

■ Expanding function

The control system can control not only the main control panel for standard equipment, but also can control auxiliary control panel and independent control panel. It can maximum control 4 massage pump through by the auxiliary control panel. Independent control panel can specially control the option equipment by itself.

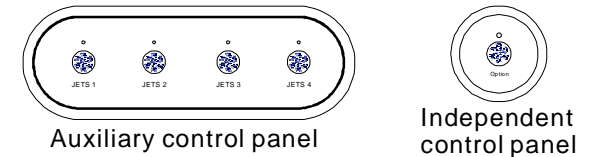

Note: The control system can control up to one auxiliary control panel and 5 independent control panel.

■ Default setting

Temperature: 38°C.

Model: Standard model.

First filter cycle (filter 1): (8:00AM-10:00AM or 8:00-10:00).

Second filter cycle (filter 2): (8:00PM-10:00PM or 20:00-22:00).

The default automatic turn off time is 15 minutes.

DIP SWITCH SETTING

DIP switch setting is for professionals only the control system has different control programs setting available, you can change the DIP switch to adjust the modes. The DIP switch setting must be set by professional personnel. Damage may be caused by wrong setting will not be covered in warranty.

Setting Mode	ON	OFF	Default setting
1	OFF(DIP 1)/OFF(DIP 2), Heat pump only mode. OFF(DIP 1)/ON(DIP 2), Heater only mode.		According to heater system selected.
2	ON(DIP 1)/OFF(DIP 2), Heater work with Heat pump mode. ON(DIP 1)/ON(DIP 2), Heat exchanger work mode.		
3	Pump 1 is two speed pump, low speed as circulation function	Pump 1 is single speed pump	According to massage pump 1 type.
4	Pump 2 is two speed pump	Pump 2 is single speed pump	OFF
5	E8 mode (dismiss compressor protection)	E8 mode (compressor protection)	ON
6	Fahrenheit Temperature display	Centigrade Temperature display	OFF
7	24 hours timing	12 hours timing	OFF
8	Dismiss water flow switch detective	water flow switch detective on	ON
9	Dismiss "E5" High/Low voltage detective	"E5" High/Low voltage detective	OFF
10	Standard mode	Hotel project mode	ON
11	OFF (DIP 11)/OFF (DIP 12): Any one water pump running high speed, the heater stop working. OFF (DIP 11)/ON (DIP 12): Any two pumps running high speed, the heater stop working.		OFF(DIP 11)/OFF(DIP 12)
12	ON (DIP 11)/OFF (DIP 12): Any three pumps running high speed, the heater stop working. ON (DIP 11)/ON (DIP 12): Any pumps and the heater can run at the same time.		

SPA - TECH CONTROL SYSTEM CIRCUIT DIAGRAM

■ SPA - Tech control system master circuit diagram

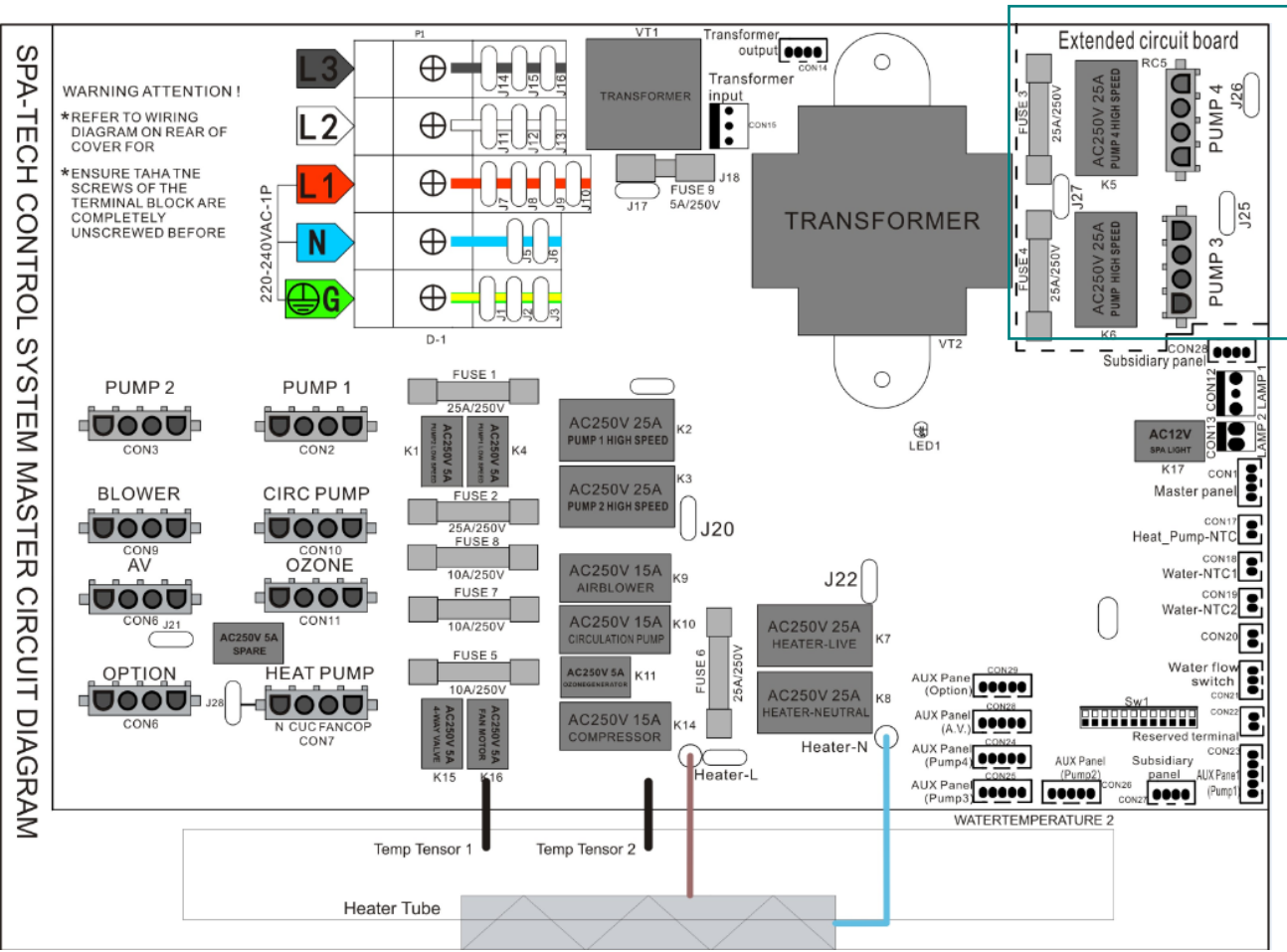

■ SPA - Tech extension circuit diagram

SPA - Tech control system have the extension function after the extension control circuit board is set inside the control box. Following is the wiring reference for the circuit diagram of the extension control board:

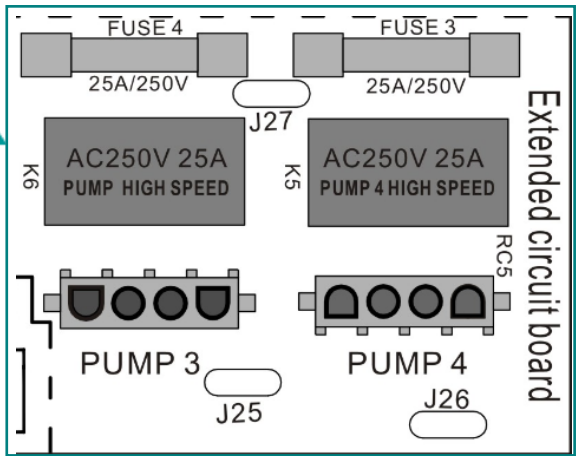

VOLTAGE JUMPER SET UP

This system has designed phase splitter to meet the requirement of AC220V and AC380V, the jumper set up reference as following:

Power input	Line input connection	Jumpers
AC230V	L1-N-G	J20-J7 / J22-J8 J27-J9 J10
AC380V	L3-L2-L1-N-G	J20-J11 / J22-J12 J27-J14 J15

PROBLEM SHOOTING

- **Message E0-> Communication Malfunction**

Phenomenon: Control Panel display E0, none of the keys respond.

Causes: The connection between the control panel and main PCB loosed.

Solutions: 1. Tighten the connection between control panel and main PCB.
2. Contact your dealer, replace the PCB or control panel.

- **Message E1-> Water temperature sensor 1 protection.**

Phenomenon: Control panel display E1, none of the keys respond. The circulation pump works for 1 minute and then stops.

Causes: 1. The connection between the temperature sensor 1 and main PCB loosed.
2. Temperature sensor 1 fault.

Solutions:
1. Tighten the temperature sensor 1 and control panel following the wiring diagram.
2. Replace the temperature sensor 1.

- **Message E2-> Water temperature sensor 2 protection.**

Phenomenon: Control Panel display E2, none of the keys respond. The circulation pump works for 1 minute and then stops.

Causes: 1. The connection between the temperature sensor 2 and main PCB loosed.
2. Temperature sensor 2 fault.

1. Tighten the temperature sensor 2 and control panel following the wiring diagram.
2. Replace the temperature sensor 2.

- **Message E3-> Heat pump copper tube temperature sensor protection.**

Phenomenon: Control Panel display E3, none of the keys respond. The circulation pump works for 1 minute and then stops.

Causes: 1. The connection between the temperature sensor and main PCB loosed.
2. Temperature sensor fault.

Solution:
1. Tighten the temperature sensor and control panel following the wiring diagram.
2. Replace the temperature sensor.

- **Message E4-> Water flow switch protection.**

Phenomenon: Control Panel display E4, none of the keys respond. The circulation pump works for 1 minute and then stops.

Causes:
1. The connection between the water flow switch and main PCB loosed.
2. Water flow switch fault.
3. Circulation tube blocked with air.

Solutions:
1. Tighten the connection between water flow switch and main PCB.
2. Replace the water flow switch.
3. Check and make sure all the side check valves are fully open. Uptight the slipknot of the circulation pump to drain out the blocked air in the plumbing.

- **Message E5-> High voltage or low voltage protection.**

Phenomenon: Control Panel display E5, none of the keys respond. The circulation pump works for 1 minute and then stops.

Causes:
1. Power supply voltage is higher/ lower than the spa rated voltage.
2. power receptor in PCB fault.

Solutions:
1. Cut off the power supply, check and make sure the power supply according to Spa rated power supply requirement.

- **Message E8-> Heat pump compressor high/low pressure protection.**

Phenomenon: Control Panel display E8, none of the keys respond. The circulation pump works for 1 minute and then stops.

Causes: Heat pump compressor high/low pressure.

Solution:

Shut off the power supply, disconnect the heat pump, check if the power cables and signal cables are correctly connected, if the problem persists, contact your dealer.

- **Message E9-> Inadequate water flow or incorrect water level protection.**

Phenomenon: Control Panel display E9, none of the keys respond. The circulation pump works for 1 minute and then stops.

Causes: Inadequate water flow or incorrect water level protection from heater.

Solution:

1. Check and make sure all the side check valves are fully open. Cut off the power supply, uptight the slip knot of the circulation pump or dual speed pump to drain out the blocked air in the plumbing and power on again.
2. check if the heater sensors broken.
3. If the problem persists, contact your dealer.

- **Message C - Low temperature protection.**

Phenomenon: Control Panel display C message, none of the keys respond, circulation pump is working, and heater is working automatically.

Causes: 1. Actual water temperature $\leq 6^{\circ}\text{C}$.
2. Temperature sensor fault.

Solution:

1. Heater will heat till the spa water temperature has arisen up to 9°C , then the message "C" disappears.
2. If the actual temperature stays below 6°C for long time, please contact your dealer.

- **Message H-> High temperature protection.**

Phenomenon: Control Panel display H message, none of the keys respond, heater stops working, circulation pump working automatically.

Causes: 1. The detected water temperature $\geq 43^{\circ}\text{C}$.
2. Temperature sensor fault.

Solution:

1. Shut off the power and wait till spa water temperature $< 41^{\circ}\text{C}$.
2. If the problem persists, contact your dealer.

- **Message HH-> Over heat protection**

Phenomenon: Control Panel display HH message, none of the keys respond, and all the equipments are shut down.

Causes: 1. The detected water temperature $\geq 47^{\circ}\text{C}$.
2. The temperature sensor fault;

Solution:

1. Cut off the power supply, wait the water to cool down $< 41^{\circ}\text{C}$.
2. If the problem persists, contact your dealer for help.

- **Message PL-> Control panel locked**

Phenomenon: the screen displays PL message, all the buttons are unavailable

Causes: The panel is locked;

Solution: Press the button "WARM" and "COOL" simultaneously to unlock the panel.

- **Message HPL -> Defrost Cycle**

Phenomenon: Control Panel display HPL, ❄ keep flashing.

The defrost cycle will end when one of the following conditions is present:

- a. The condenser temperature is above 3°C during the defrost cycle.
- b. The defrost cycle has run for more than 3 minutes.

YC-01