

BP200G2 Tech Sheet

Customer: Balboa Water Group

Part Number: 59285-01 3.0kW 800 Incoloy
59287-01 2.0kW 800 Incoloy

Custom Box Overlay
Box Overlay Part Number N/A

CE System Model For 2.0KW: BP2-BP200G2-RCA-2.0KW
CE System Model For 3.0KW: BP2-BP200G2-RCA-3.0KW
Software Version ID: M100_235 V52.0
Software Version: 52.0
File Name: BP200_52.0_BP200G2.hex
Configuration Signature: 89CA476C

Eng. Project Number: 5270

Control Panels (See later pages for more information):

spaTouch™2 Any version (version 2.0 or later required for bba™2 fully integrated functionality)
Icon spaTouch™ Any version (version 3.36 or later required for bba™2 fully integrated functionality)
Menued spaTouch™ Any version (version 2.8 or later required for bba™2 integrated functionality)
TP800 Version 3.1 and later (Version 3.13 or later required for bba™; version 4.11 or later required for bba™2 integrated functionality)
TP600 Version 2.7 and later (Version 2.12 or later required for bba™/bba™2 On/Off control via menu)
TP500 Any version
TP400T CE Version 2.7 and later (TP400T US should not be used) (Version 2.12 or later required for bba™/bba™2 On/Off control via menu)
TP400W CE Version 2.7 and later (TP400W US should not be used) (Version 2.12 or later required for bba™/bba™2 On/Off control via menu)

Manufactured under one or more of these patents. U.S. Patents: 5332944, 5361215, 5550753, 5559720, 5,883,459, 6253227, 6282370, 6590188, 6976052, 6965815, 7030343, 7,417,834 b2, Canadian Patent: 2342614, Australian patent: 2373248 other patents both foreign and domestic applied for and pending. © Copyright 2009 Balboa Water Group.

System Revision History

Part #	EPN	Date	Originator	Changes Made
59285 59287	5205	05-07-19	BWG	Generic BP200G2 system, supporting most of the Setups the BP200 board can do with a pump expander board.
59285-01 59287-01	5270	09-05-19	BWG	Update software for full TP500 compatibility.

bba™ & bba™2 (Balboa Bluetooth Amp) connection is documented seperately.

bba™ is integrated into graphic display panels (TP800, TP900 and spaTouch™). With TP600/TP500/TP400, use the “BT” entry on the menu to toggle bba™ power On/Off.

bba™2 is integrated into graphic display panels (TP800, TP900 and spaTouch™). With TP600/TP500/TP400, use the “BT” entry on the menu to toggle bba™2 power On/Off.

Basic Functions Setup 1 - 4

Power Requirements:

Single Service [3 wires (line, neutral, ground)]

230VAC, 50/60Hz*, 1p, 16A, (Circuit Breaker rating = 20A max.)

Single Service [3 wires (line, neutral, ground)]

230VAC, 50/60Hz*, 1p, 32A, (Circuit Breaker rating = 40A max.)

2-out-of-3-Service [4 wires (line 1, line 2, no line 3, neutral, ground)]

230VAC line-to-neutral**, 50/60Hz*, 2/3p, 16A, (Circuit Breaker rating = 20A max each phase line.)

NOTE: 2-out-of-Service is simply 3-Service (single common) with one of the three lines unused. The third line could be used for a slave heater if desired, or left for a use not related to the spa at all.

*BP systems automatically detect 50Hz vs 60Hz. However, power frequency (50Hz vs 60Hz) is just one of many differences between North American (UL) and CE power, and it is because of these other differences that different BP systems must be used for UL vs CE territories. Also, there are a few countries that use CE power but 60 Hz (such as South Korea) which need CE systems, and a few countries that use UL power but 50 Hz which need UL systems.

** 3-phase service measured line-to-line will read about 400V, but BP systems do not use it line-to-line.

IMPORTANT - Service must include a neutral wire, with a line to neutral voltage of 230VAC.

HiPot Testing Note:

Disconnect slip terminal with green wires from J6 prior to performing HiPot test. Failure to disconnect may cause a false failure of the test. Reconnect terminal to J6 after successful completion of HiPot test.

2-out-of-3-Service wiring options with Pump 2:

Pump 2 can either be wired to the Heater service or to the Pump 1 service.

If Pump 2 is wired to the Heater service, DIP Switch A8 ON (with other DIO switches OFF) makes Pump 2 shut OFF the heater, but lets Pump 1 run along with the Heater.

If Pump 2 is wired to the Pump 1 service, then the heater can always run (with DIP switches A2 and A3 both ON). However, in most cases DIP Switch A5 also has to be ON, which only allows either Pump 1 or Pump 2 (not both) to be at High Speed at the same time. The only case where DIP Switch A5 can be turned OFF is if both pumps are small enough to fit in a single 16A service together with both pumps at High Speed, together with any other equipment such as A/V.

When not using Pump 2, ie in Setups 3 & 4, the heater can run at any time with either of the above DIP switch settings.

Basic Functions Setup 1 - 4

System Outputs:

Pump 1	230VAC	2-Speed	12A max	15-minute timer for High Speed 30-Minute timer for Low Speed	
		This is the heater pump in Setups 2 & 4. Must deliver 20 GPM through heater			
		1 Speed in Setups 1 & 3			
Pump 2	230VAC	1-Speed	12A max	15-minute timer -----	<input checked="" type="checkbox"/>
		Unused in Setups 3 & 4			
Circ Pump	230VAC	1-Speed	2A max	Programmable Filtration Cycles + Polling	
		This is the heater pump in Setups 1 & 3. Must deliver 20 GPM through heater			
Ozone	230VAC		.5A max	Slaved to Circ Pump in Circ Setups and to Pump 1 Low in Non-Circ Setups	
Spa Light	10VAC	On/Off	1A max	240-minute timer.	
A/V (Stereo)	230VAC	Hot	2A max	Always on	
Heater	3.0kW @ 240VAC max				

In Group 3:

Hardware Setup

Wiring Diagram

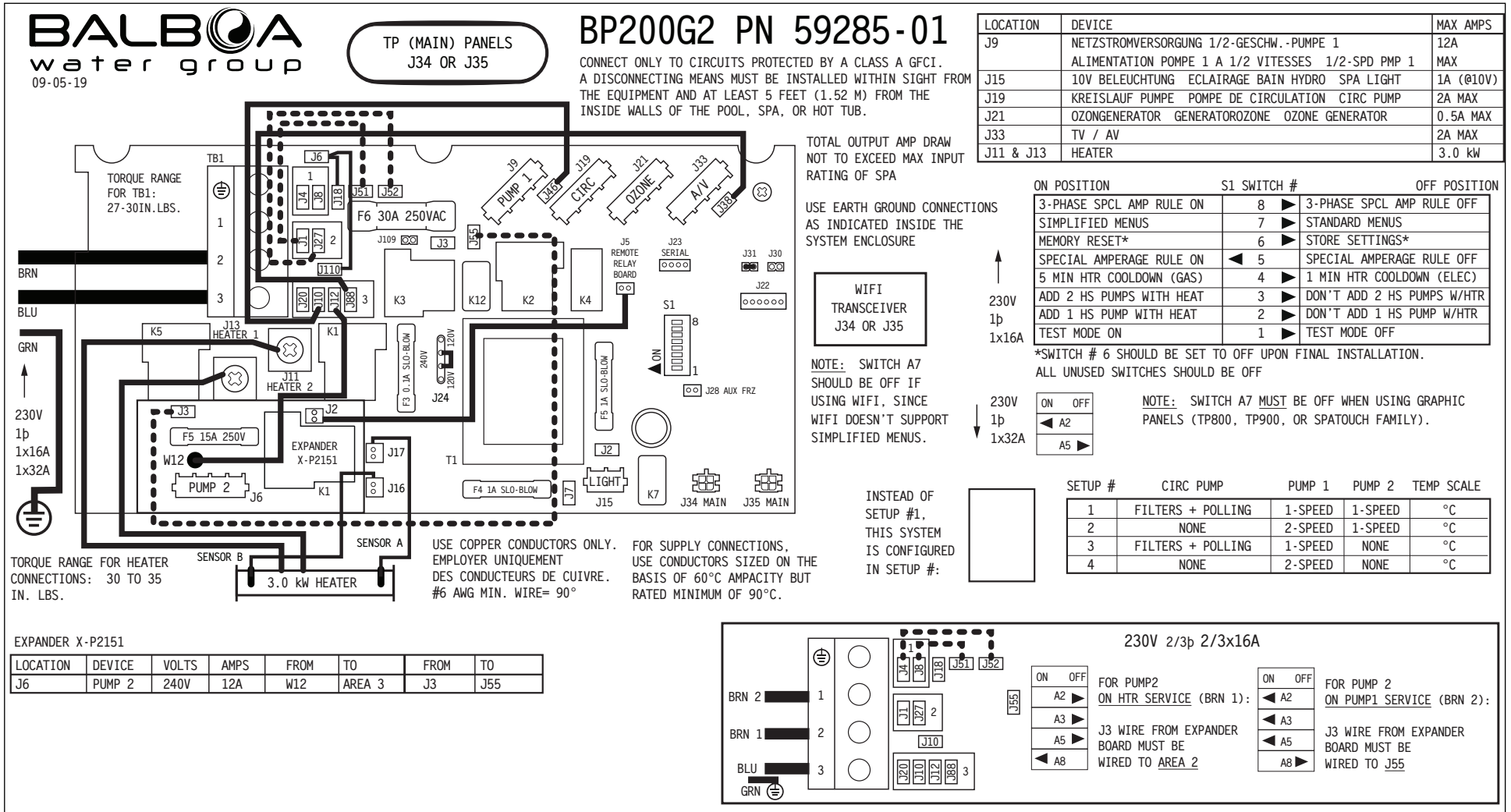

Setup Reference Table

Setup #	Circ Pump	Pump 1	Pump 2	Temp Scale
1	Programmable Filtration + Polling	1-Speed	1-Speed	°C
2	None	2-Speed	1-Speed	°C
3	Programmable Filtration + Polling	1-Speed	None	°C
4	None	2-Speed	None	°C

System (and any replacement board) is shipped in Setup 1

Manufactured under one or more of these patents. U.S. Patents: 5332944, 5361215, 5550753, 5559720, 5,883,459, 6253227, 6282370, 6590188, 6976052, 6965815, 7030343, 7,417,834 b2, Canadian Patent: 2342614, Australian patent: 2373248 other patents both foreign and domestic applied for and pending. © Copyright 2009 Balboa Water Group.



Changing Software Setups with spaTouch™ Icon-Driven Panels

Test Menu Access (S1, Switch 1 ON) *Service Technician ONLY.*

DANGER! HIGH VOLTAGE WILL BE ACCESSIBLE! SERVICE TECHNICIAN ONLY!

While the system is running, move DIP Switch 1 (on S1 on the Main circuit board) to ON. The system will enter Test Mode. Moving DIP Switch 1 to OFF will exit Test Mode.

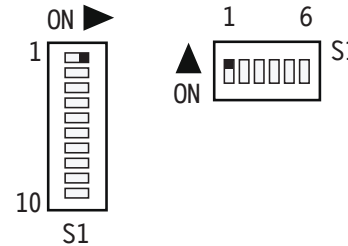

The example screens shown here are from the spaTouch 1 Icon-Driven Panel, but the screens on the spaTouch 2 Panel are similar. The main difference is that the spaTouch 2 display is wider.

To Change Software Setups:

While in Test Mode, press the indicated icons to move from screen to screen.

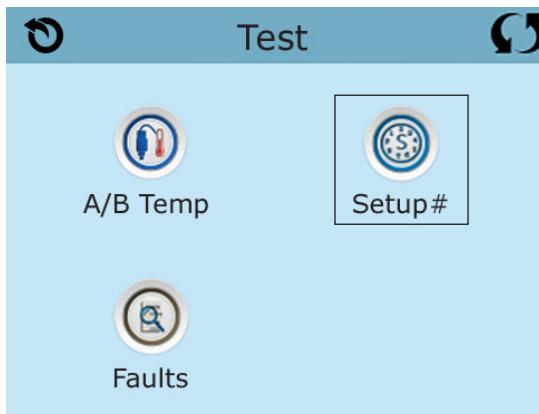
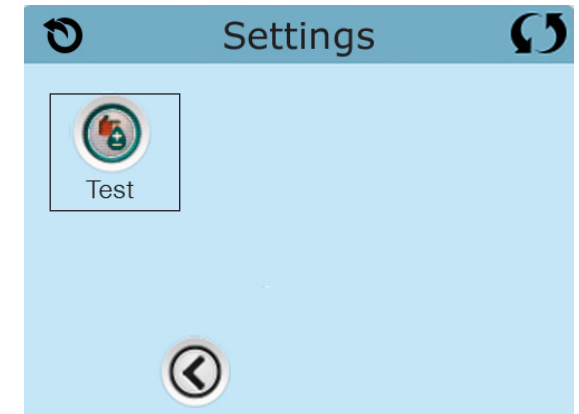
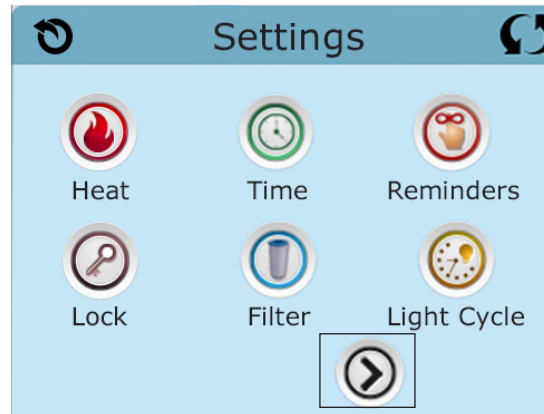
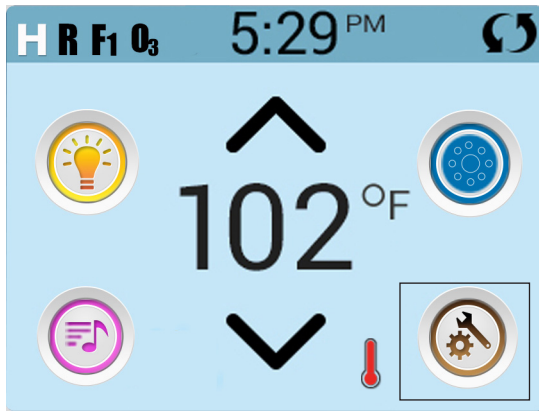

Once on the Setup Selection screen, press the Up or Down icon to select the desired Setup Number, then press the Check Mark icon to confirm and to have the spa restart.

After the system restarts, you may see a message that "The settings have been reset"; this is normal after changing Setups with DIP Switch 6 in the OFF position. Press "Clear" to dismiss this message.

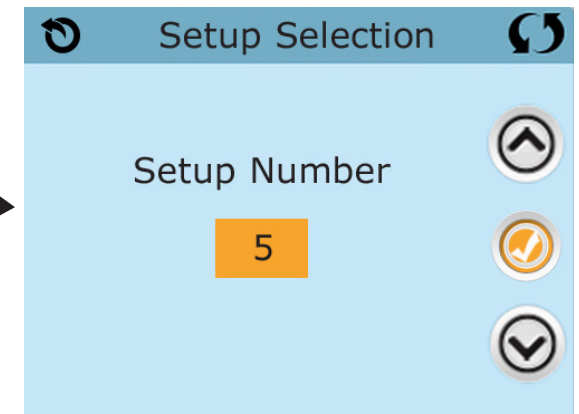

Changing Software Setups with TP800 / TP900 / spaTouch™ Menued Panel

Test Menu Access (S1, Switch 1 ON) *Service Technician ONLY.*

DANGER! HIGH VOLTAGE WILL BE ACCESSIBLE! SERVICE TECHNICIAN ONLY!

While the system is running, move DIP Switch 1 (on S1 on the Main circuit board) to ON.
The system will enter Test Mode.
Moving DIP Switch 1 to OFF will exit Test Mode.

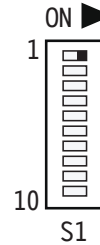

Software Setups

Under the TEST Menu, the Setup screen will allow changing the Setup from 1 to any number established by the Manufacturer.
Changing the Setup may require wiring changes as well.

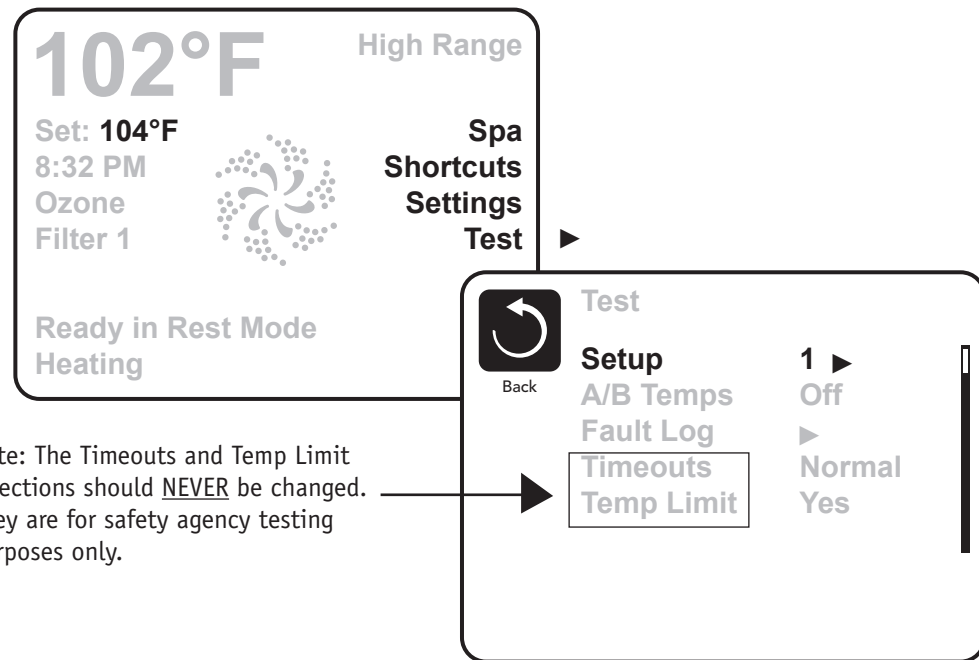

Note: The Timeouts and Temp Limit selections should NEVER be changed. They are for safety agency testing purposes only.

Changing Software Setups with TP600 / TP500 / TP400

Test Menu Access (S1, Switch 1 ON) *Service Technician ONLY.*

DANGER! HIGH VOLTAGE WILL BE ACCESSIBLE! SERVICE TECHNICIAN ONLY!

While the system is running, move DIP Switch 1 (on S1 on the Main circuit board) to ON. The system will enter Test Mode. Moving DIP Switch 1 to OFF will exit Test Mode.

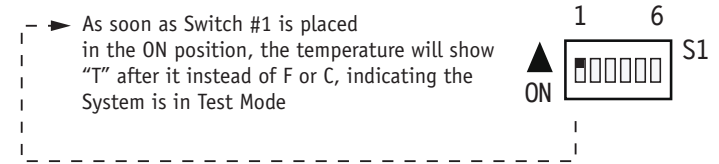

Software Setups

Under the TEST Menu, the Setup screen will allow changing the Setup from 1 to any number established by the Manufacturer. Changing the Setup may require wiring changes as well.

You will have 1 minute to complete the setup change after you manually exit Priming Mode. (Once familiar with the process, the Setup change should take less than 15 seconds.)



When the panel displays RUN PMPS PURG AIR, press any Temperature button ONCE to exit Priming Mode. You should see “---T” where the T indicates the system is in Test Mode.

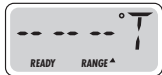

Continued on Next Page.

Changing Software Setups with TP600 / TP500 / TP400 Continued

Again, **You will have 1 minute** to complete the setup change after you manually exit Priming Mode.

NOTE: Wherever the below says Warm or Temp followed by Light, on the TP500 press Menu instead of Warm or Temp followed by light. And whenever the chart below says Light, on the TP500 press Menu instead of Light.

Immediately after exiting Priming Mode, press this sequence of buttons: Warm*, Light, Warm, Warm, Warm, Warm. Continue to press Warm until the display shows the Setup Number (S-01, S-02, etc.) you want to switch to. When the correct setup number is showing, press Light once, and the system will reset, using the newly-selected Setup from that point on.

Move DIP Switch 1 to the OFF position to take the spa out of Test Mode. °F or °C will replace °T.

Using a permanent marker, write the Setup number on the Setup label mounted inside the system lid (right). This is very important to any service person in the future who may need to replace a circuit board or system and needs to change the Setup on a replacement part while in the field.

NOTE: Changing the Setup may require wiring changes as well - refer to the wiring diagram or wiring diagram addendum.

THIS SYSTEM IS CONFIGURED AS SETUP #

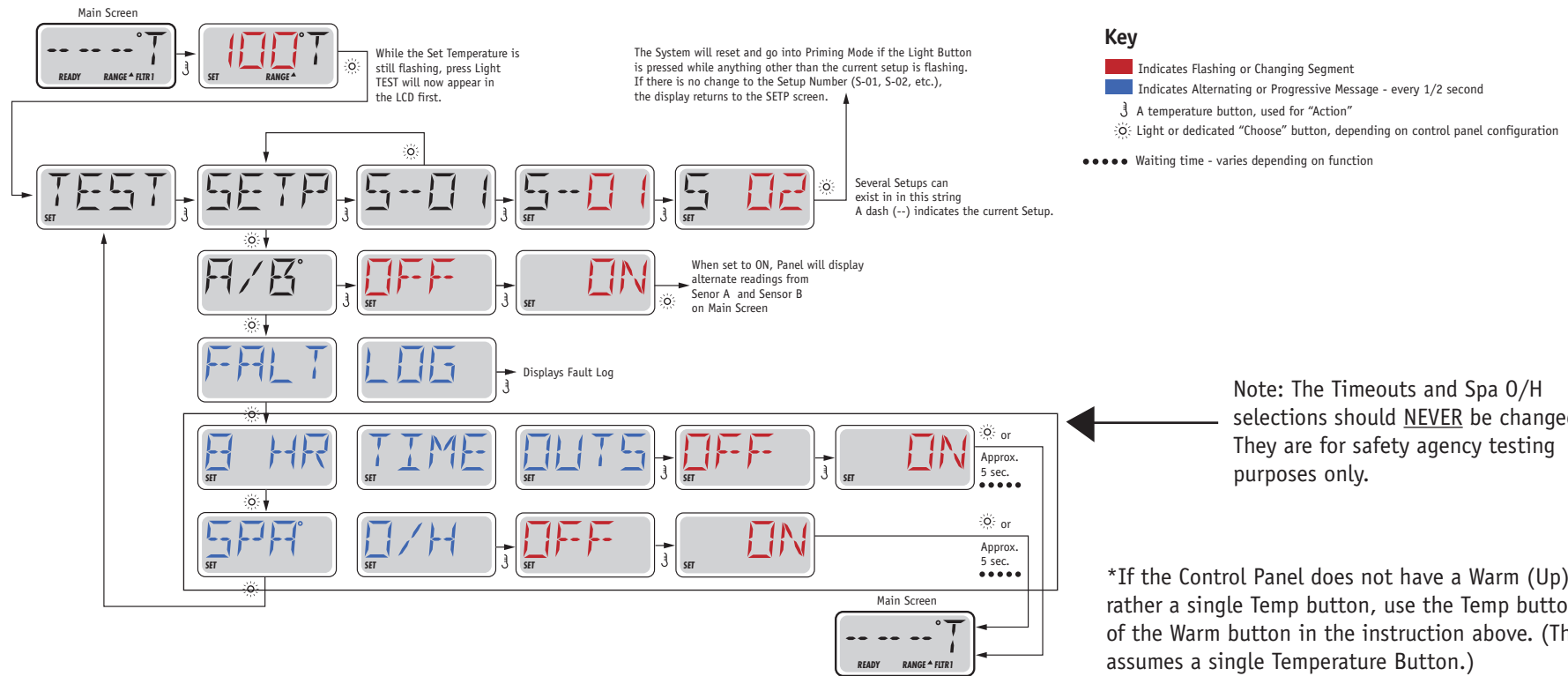
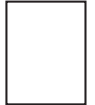

Equipment Expansion

Expansion Features

Control Connection

Relay 1 (J5)

Default

1-Speed Pump 2

Fuse

15A

DIP Switch Functions

Fixed-function DIP Switches

- | | |
|----|--|
| A1 | Test Mode (normally Off). |
| A2 | In "ON" position, add one high-speed pump (or blower) with Heater. |
| A3 | In "ON" position, add two high-speed pumps (or 1 HS Pump and Blower) with Heater. |
| A5 | In "ON" position, enables Special Amperage Rule B. See Special Features section under Configuration Options for functionality with your system.
In "OFF" position, enables Special Amperage Rule A. |
| A6 | Persistent memory reset (Used when the spa is powering up to restore factory settings as determined by software configuration). |



A2 and A3 work in combination to determine the number of high-speed devices and blowers that can run before the heat is disabled. i.e. A2 and A3 in the ON position will allow the heater to operate with up to 3 high-speed pumps (or two HS Pumps and Blower) running at the same time. Heat is disabled when the fourth high-speed pump or blower is turned on.



Note: A2/A3 all off = No heat with any high-speed pump or blower.

Assignable DIP Switches

- | | |
|----|--|
| A4 | In "ON" position, enables a 5-minute cooldown for some gas heaters (Cooling Time B).
In "OFF" position, enables a 1-minute cooldown for electric heaters (Cooling Time A). |
| A7 | In "ON" position, Simplified Menus on TP400/TP500/TP600. <u>Do not</u> use graphic panels (TP800, TP900, or spaTouch™ family) with Simplified Menus.
In "OFF" position, Regular Menus on TP400/TP500/TP600. This setting is compatible with all panels. |
| A8 | In "ON" position, 3-Phase Special Amperage Rule is enabled.
In "OFF" position, 3-Phase Special Amperage Rule is disabled. |

Undesignated switches are not assigned a function.

Jumper Definitions

J109	Non Applicable on CE models	J109 
J30	Do Not Use	
J31	Jumper on 1 pin with 2.0kW or smaller heater Jumper on 2 pins with a 3.0kW or higher heater	<p>Jumper setting varies by system model which is shown to the right of the jumper.</p> <p>J31  for 2kW models</p> <p>J31  for 3kW models</p>

J44	Jumper must be on center two pins (240V) for CE Systems.	
------------	--	---

Warning!

Setting DIP switches or jumpers incorrectly may cause abnormal system behavior and/or damage to system components. Refer to Switchbank illustration on Wiring Configuration page for correct settings for this system. Contact Balboa if you require additional configuration pages added to this tech sheet.

Replacement Parts

PCBA:

Main PCBA: 59286-01 3.0kW Models
59288-01 2.0kW Models
Expander PCBA: 59233

HEATER(s):

Heater: 58419 3.0kW 800 Inc
58427 2.0kW 800 Inc
Temp Sensor Kit: 30344KIT 12-inch sensor
30382KIT 24-inch sensor

CABLES:

N/A

FUSES:

Part Number	Amperage	Location
30136	30A	F6
26983	1A	F4, F5 on main board
24514	0.1A SLO	F3
24517	15A	F5 on expander

BP200 Configuration Options

General Features

Feature	Default	
Pump 1 in Filter Cycle (Circ Only)	No	
Pump 1 Low Timer	30 Minutes	Applies in non-circ Setups (configurations) only
General Pump Timer	15 Minutes	
Blower Timer	15 Minutes	
Mister Timer	15 Minutes	
Light Timer	240 Minutes	
Circ (when enabled)	Programmable + Polling	
Cleanup Cycle	<i>30 Minutes</i>	
Cleanup as Preference setting	<i>Yes</i>	
Ozone	With Heater Pump*	
Ozone Suppression	OFF	
Pump Purge	60 Seconds	
Blower Purge	30 Seconds	
Mister Purge	5 Seconds	
Purge Type	Serial - Pumps at lowest speed	

* The heater Pump can be either a Circ Pump or Pump 1 Low.

BP200 Configuration Options

Temperature Features

Feature	Default
Temperature Display	°C

All temperatures must be specified in °F. The system converts °F to °C dynamically. If Celsius is required for default settings, choose a desired °C value that (after rounding) corresponds to a Fahrenheit value.

°C	4	5	6	7	8	9	10	11	12	13	14	15	16	17	18	19	20	21	22
°F	39	41	43	45	46	48	50	52	54	55	57	59	61	63	64	66	68	70	72
°C	23	24	25	26	27	28	29	30	31	32	33	34	35	36	37	38	39	40	
°F	73	75	77	79	81	82	84	86	88	90	91	93	95	97	99	100	102	104	

Hi-Range Min. Set Temp	80°F
Hi-Range Max. Set Temp	104°F
Hi-Range Default Temp*	100°F
Lo-Range Min. Set Temp	50°F
Lo-Range Max. Set Temp	99°F
Lo-Range Default Temp*	70°F
Freeze Threshold	44°F in Setups 1 & 2
Freeze Type	Rotating - Pumps at Lowest Speed
Temp Lock Type	Temp + Settings

**May be changed by end-user (if enabled)*

Manufactured under one or more of these patents. U.S. Patents: 5332944, 5361215, 5550753, 5559720, 5,883,459, 6253227, 6282370, 6590188, 6976052, 6965815, 7030343, 7,417,834 b2, Canadian Patent: 2342614, Australian patent: 2373248 other patents both foreign and domestic applied for and pending. © Copyright 2009 Balboa Water Group.

BP200 Configuration Options

Time Features

Feature	Default
Time Format*	24 Hour
Filter 1 Start Hour*	20:00 (8:00 PM)
Filter 1 Duration*	2 Hours
Filter Cycle 2 Default*	OFF
Filter 2 Start Hour*	08:00 (8:00 AM)
Filter 2 Duration*	15 Minutes
Light Cycle	Disabled
Light Cycle Default*	OFF
Light Cycle Start Hour*	21:00 (9:00 PM)
Light Cycle Duration*	15 Minutes
Cooling Time A	1 Minute
Cooling Time B	5 Minutes

**May be changed by end-user (if enabled)*

Manufactured under one or more of these patents. U.S. Patents: 5332944, 5361215, 5550753, 5559720, 5,883,459, 6253227, 6282370, 6590188, 6976052, 6965815, 7030343, 7,417,834 b2, Canadian Patent: 2342614, Australian patent: 2373248 other patents both foreign and domestic applied for and pending. © Copyright 2009 Balboa Water Group.

BP200 Configuration Options

Reminder Features

Feature	Default
Reminders Shown*	<i>Yes</i>
Check pH	<i>OFF</i>
Check Sanitizer	<i>OFF</i>
Clean Filter	30 Days
Test GFCI	OFF
Drain Water	<i>100 Days</i>
Change Cartridge	OFF
Clean Cover	<i>OFF</i>
Treat Wood	<i>OFF</i>
Change Filter	365 Days

**May be changed by end-user (if enabled)*

Manufactured under one or more of these patents. U.S. Patents: 5332944, 5361215, 5550753, 5559720, 5,883,459, 6253227, 6282370, 6590188, 6976052, 6965815, 7030343, 7,417,834 b2, Canadian Patent: 2342614, Australian patent: 2373248 other patents both foreign and domestic applied for and pending. © Copyright 2009 Balboa Water Group.

BP200 Configuration Options

Special Features

Feature	Default
Special Amperage Rule A	No Limitation
Special Amperage Rule B	1 Pump at High Speed maximum
3-Phase Special Amperage Rule	Pumps in Group 3 (ie, Pump 2) are the only ones which turn the Heater Off Pumps not in Group 3 (ie, Pump 1) do not turn the Heater OFF
Drain Mode	Disabled
Demo Mode	Disabled
GFCI Trip	Not Applicable for CE Models
Automatic GFCI Test	Disabled
Ozone Slaved to Heater Pump	Yes
Dual Voltage Heater	Always Input Voltage
Safety Suction	Disabled
Menu Style	Standard Menus when DIP switch A7 is OFF. Simplified Menus when DIP switch A7 is ON..

TP900 Panel Configuration

Button Layout Table

Button #	Setup 1	Setup 2	Setup 3	Setup 4
1	N/A	N/A	N/A	N/A
2	Jets 1	Jets 1	Jets 1	Jets 1
3	Jets 2	Jets 2	Light	Light
4	Light	Light	Invert	Invert
5	Invert	Invert	(Circ Icon)	Undefined
6	(Circ Icon)	Undefined	Undefined	Undefined
7	Undefined	Undefined	Undefined	Undefined
8	Undefined	Undefined	Undefined	Undefined
9	Undefined	Undefined	Undefined	Undefined
10	Undefined	Undefined	Undefined	Undefined
11	N/A	N/A	N/A	N/A
12	N/A	N/A	N/A	N/A
13	Jets 1	Jets 1	Jets 1	Jets 1
14	Jets 2	Jets 2	Undefined	Undefined
15	Light	Light	Light	Light
16	Invert	Invert	Invert	Invert

Spa Screen

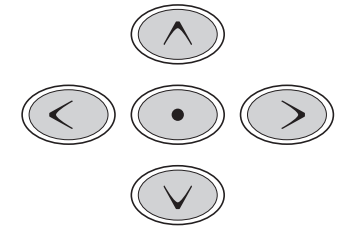
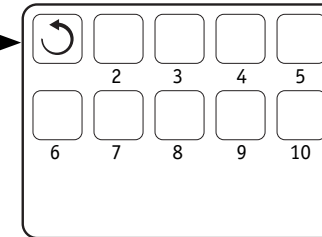

Shortcuts Screen

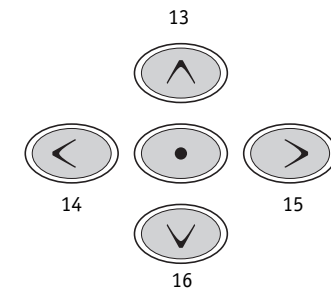
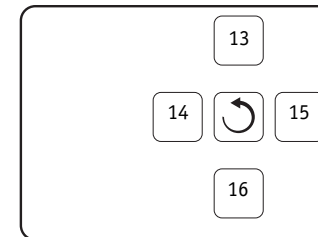

A Circ Icon will appear when a Circ Pump is configured

TP800 Panel Configuration

Button Layout Table

Feature #	Setup 1	Setup 2	Setup 3	Setup 4
A1	N/A	N/A	N/A	N/A
A2	Jets 1	Jets 1	Jets 1	Jets 1
A3	Jets 2	Jets 2	Light 1	Light 1
A4	Light	Light	Invert	Invert
A5	Invert	Invert	(Circ Icon)	Undefined
A6	(Circ Icon)	Undefined	Undefined	Undefined
A7	Undefined	Undefined	Undefined	Undefined
A8	Undefined	Undefined	Undefined	Undefined
A9	Undefined	Undefined	Undefined	Undefined
A10	Undefined	Undefined	Undefined	Undefined
A11	N/A	N/A	N/A	N/A
A12	N/A	N/A	N/A	N/A
A13	Undefined	Undefined	Undefined	Undefined
A14	Undefined	Undefined	Undefined	Undefined
A15	Undefined	Undefined	Undefined	Undefined
A16	Undefined	Undefined	Undefined	Undefined
B1	Jets 1	Jets 1	Jets 1	Jets 1
B2	Jets 2	Jets 2	Undefined	Undefined
B3	Undefined	Undefined	Undefined	Undefined
B4	Light 1	Light 1	Light 1	Light 1

TP800 Panel Configuration

Spa Screen

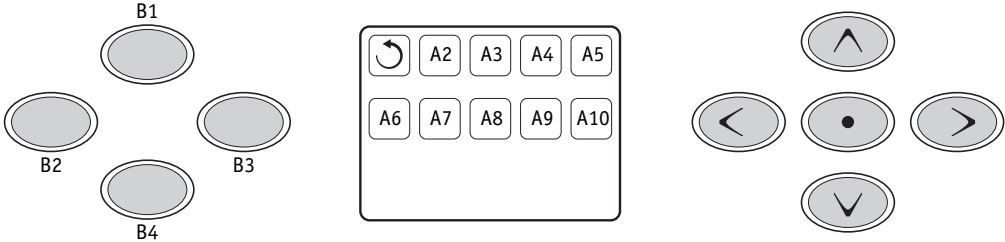

Shortcuts Screen

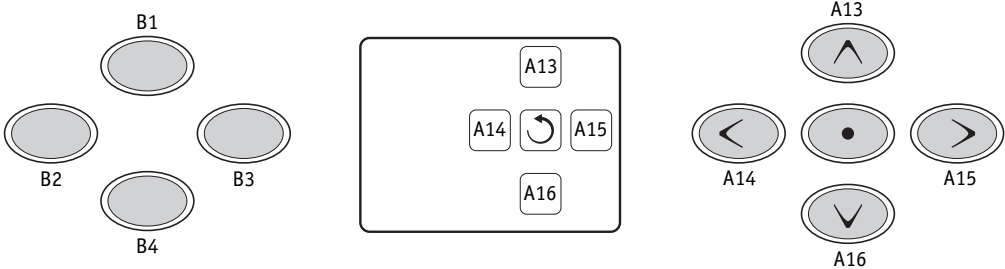

Note: Buttons 11 and 12 are not used in this configuration.

Button 1 is fixed.

TP600 Panel Configuration

Button Layout Table

Button #	Setups 1 & 2	Setup 3 & 4
1	Jets 1	Jets 1
2	Jets 2	Undefined
3	Invert	Invert
4	Up	Up
5	Light 1	Light 1
6	Down	Down
LED 1	Jets 1	Jets 1
LED 2	Jets 2	Undefined
LED 3	Light 1	Light 1
LED 4	Heat On	Heat On

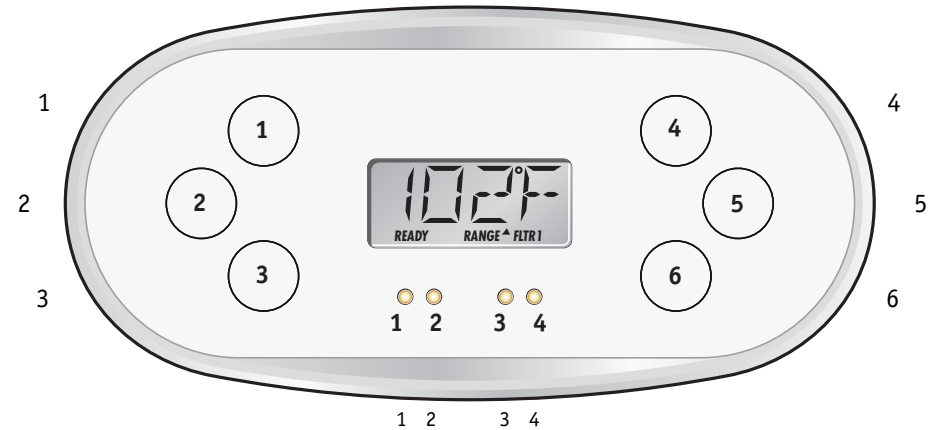

TP600

55676-XX

No Overlay

TP400 Panel Configuration

Button Layout Table for TP400T

Button #	Setup 1 & 2	Setup 3 & 4
1	Temperature	Temperature
2	Jets 1	Jets 1
3	Light 1	Light 1
4	Jets 2	Undefined
LED 1	Heater ON	Heater ON
LED 2	Jets 1 ON	Jets 1 ON
LED 3	Light ON	Light ON
LED 4	Jets 2	Undefined

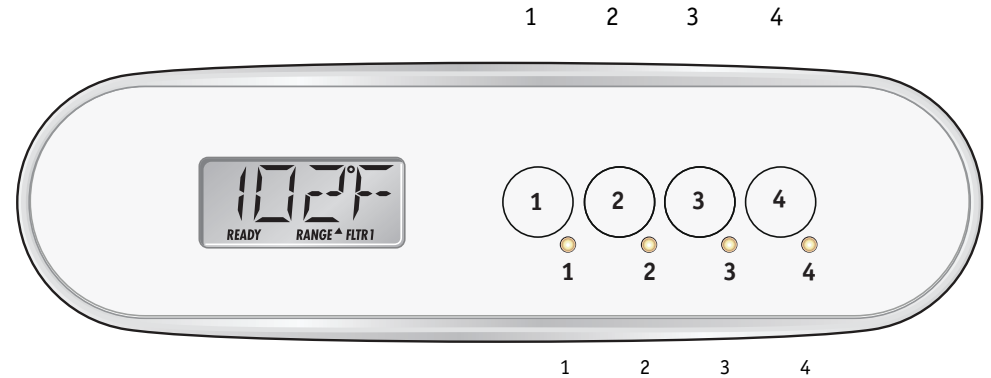

TP400T CE

50260-XX

Includes overlay PN 12511.

Button Layout Table for TP400W

Button #	All Setups
1	Up
2	Down
3	Light 1
4	Jets 1
LED 1	Heater ON
LED 2	Undefined
LED 3	Light ON
LED 4	Jets 1 ON

TP400W is supported in Setups 3 & 4 only.

TP400W CE

50259-XX

Includes overlay PN 12510.